

**HAYMAN REESE**  
**PART No: 02888RW**  
**BMW X6 01/2008 – ON (STANDARD BUMPER ONLY)**

**INSTALLATION INSTRUCTIONS**

PLEASE ENSURE THAT INSTRUCTIONS ARE UNDERSTOOD PRIOR TO FITMENT



**Installation Time: Approx 60-90 Minutes**

**Towbar Installation Instructions      Towbar capacity**  
**BMW X6 01/2008-ON (STANDARD BUMPER ONLY)**

**Part Number 02888RW**

**Max Towing Braked 2700kg**  
**Max Static Ball Load 270kg**

Hayman Reese (Cequent)  
PO Box 4050, Dandenong South VIC 3164  
Phone 1800 812 017 Email [info@haymanreese.com.au](mailto:info@haymanreese.com.au)

**HAYMAN REESE**  
**PART No: 02888RW**  
**BMW X6 01/2008-ON (STANDARD BUMPER ONLY)**

**INSTALLATION INSTRUCTIONS**

PLEASE ENSURE THAT INSTRUCTIONS ARE UNDERSTOOD PRIOR TO FITMENT

**Warning:**

1. Do not, drill, cut, weld or otherwise modify the towbar.
2. If you are using electric welding on a motor vehicle, **always** check that the vehicle is not equipped with electronic engine or instrument management equipment. Failure to do so could **destroy** any onboard computers. If in doubt, check with the vehicle's manufacturer.

**General:**

1. Ensure all hardware items have been included refer to assembly diagram.
2. It is recommended that the instructions are read through and completely understood before making any attempt to fit this product.
3. Be wary of any changes to vehicle designs or other accessories that may conflict with the installation of this product.
4. Before drilling ensure that the area is clear of fuel, electrical & other components.
5. All holes drilled into the body panels shall have all burrs & swarf removed then coated with a suitable rust preventative paint.
6. The high tensile fasteners supplied with this product were used to achieve the specified rating. If replacement is required ensure that fasteners of the same rating & quality are used. Contact an authorised **Hayman Reese** dealer if further information is required.
7. Ensure that all hardware is fastened to torque list below check fasteners on regular basis.
8. Towbar load rating sticker provided with this product shall be conspicuously located on inside rear end of the driver's door **(See diagram below)**.
9. Hayman Reese recommends that you check your tow ball to ensure that it complies with the Australian standards **AS 4177.2**.
10. **PLEASE NOTE:** It is advised to remove your lug or tbm when not actually towing so as to produce a clear view of the vehicles registration plate if obscured, and to also provide maximum available departure angle.

**Tow bar Maintenance and Care.**

Hayman Reese recommends that bolt torque's, as listed below, are routinely and regularly inspected and checked for correct tension. Replace any worn or defective parts.

We recommended to remove Tow Ball Mounts (TBM's, tongues or lugs) when not being used for any considerable length of time.

So as to avoid injury, when not towing it is suggested that the tongue, Pull Pin and R-clip are removed then stored in a safe, clean and dry place, away from excessive moisture.

Hitch Pull Pins and spring "R" clips are regularly checked for proper installation. Replace any worn or defective parts.

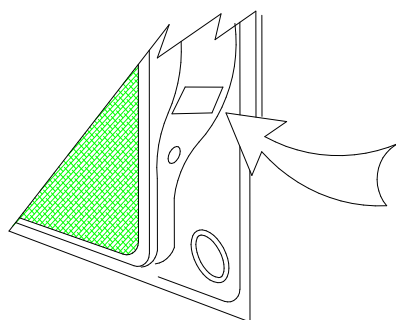

Place load rating sticker  
inside driver's door here

**RECOMMENDED ASSEMBLY TORQUE  
LISTING**

**Diameter Grade 8.8 Bolt**

M6	9.5 Nm
M8	21.7 Nm
M10	43.4 Nm
M12	77.3 Nm
M14	146 Nm
M16	189.8 Nm

**FOR TOWING PURPOSES ONLY**

For towing capacity details please refer to vehicle  
owner's manual or to the manufacturer. Overloading can  
void your warranties.

Issue Date 06/01/2012

Page 2

Rev: A

**HAYMAN REESE**  
**PART No: 02888RW**  
**BMW X6 01/2008-ON (STANDARD BUMPER ONLY)**

**INSTALLATION INSTRUCTIONS**

PLEASE ENSURE THAT INSTRUCTIONS ARE UNDERSTOOD PRIOR TO FITMENT

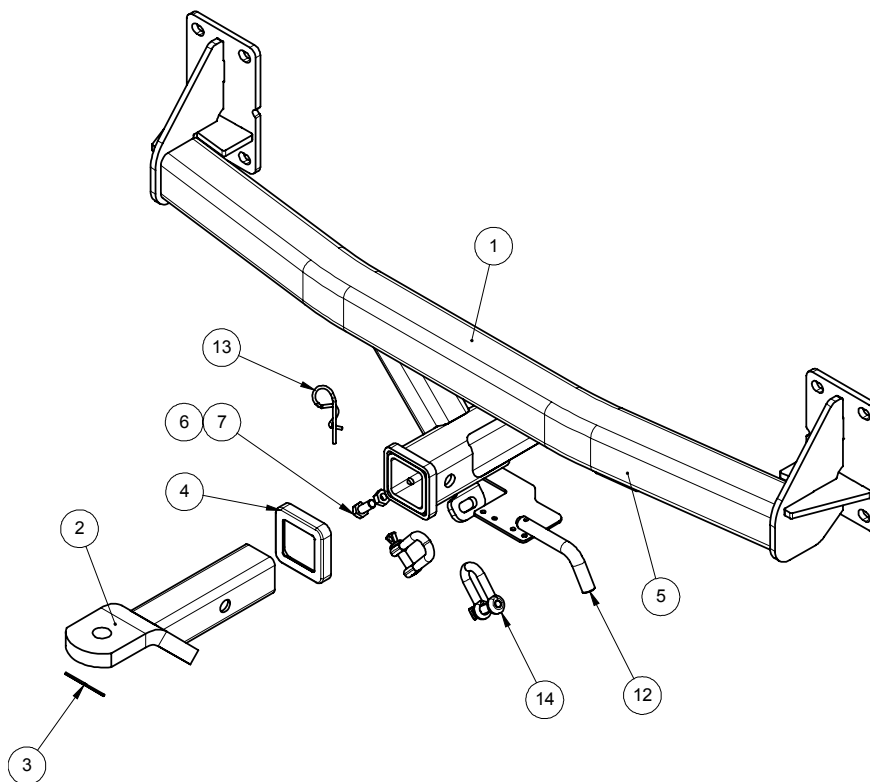



QTY.	DESCRIPTION	ITEM NO.
1	BMW X6 WELDED ASSY	1
1	T.B.MOUNT	2
1	HAYMAN REESE LOGO STICKER	3
1	Hitch Box Collar Cover	4
1	CP STICKER	5
1	NUT M 10 x 1.5 Z/P HX NUTS	6
1	BOLT M 10-1.50 x 25	7
1	PLASTIC SHEET BAG	8
1	FITTING INSTRUCTION	9
1	LRL STICKER	10
1	Warranty Card	11
1	PULL PIN	12
1	SPRING COTTER PIN	13
2	D' SHACKLE	14

**HAYMAN REESE**  
PART No: 02888RW  
BMW X6 01/2008-ON (STANDARD BUMPER ONLY)

**INSTALLATION INSTRUCTIONS**

PLEASE ENSURE THAT INSTRUCTIONS ARE UNDERSTOOD PRIOR TO FITMENT

	<ol style="list-style-type: none"><li>1. Lift rear wheel flare to remove screw in side on both sides.</li></ol>
	<ol style="list-style-type: none"><li>2. Remove screws under reflective plate.</li><li>3. Remove screws under the bumper then carefully remove bumper skin.</li></ol>
	<ol style="list-style-type: none"><li>4. Remove impact beam and discard, retain factory nuts for reuse.</li><li>5. Fit towbar using factory nuts, torque all nuts to specification.</li></ol>

**HAYMAN REESE**  
PART No: 02888RW  
BMW X6 01/2008-ON (STANDARD BUMPER ONLY)

**INSTALLATION INSTRUCTIONS**

PLEASE ENSURE THAT INSTRUCTIONS ARE UNDERSTOOD PRIOR TO FITMENT





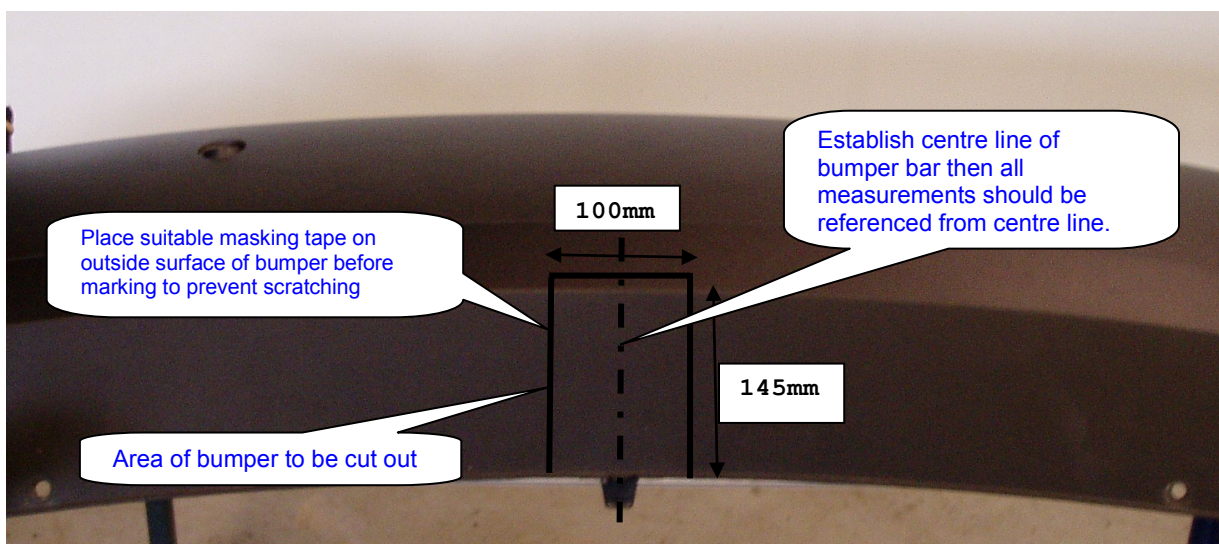

- Cut bumper according to picture below then refit bumper

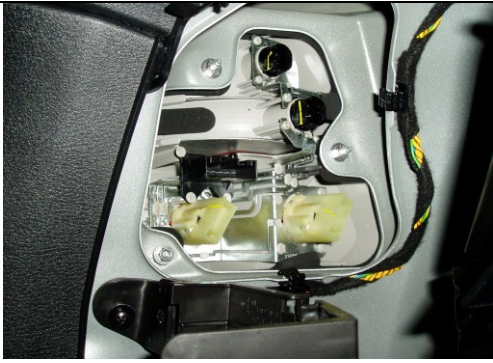

**HAYMAN REESE**  
PART No: 02888RW  
BMW X6 01/2008-ON (STANDARD BUMPER ONLY)

**INSTALLATION INSTRUCTIONS**

PLEASE ENSURE THAT INSTRUCTIONS ARE UNDERSTOOD PRIOR TO FITMENT

	<p>6. Remove taillights via 3 x M8 nuts on both sides.</p> <p>7. Remove mud flaps on both sides.</p>
	<p>8. Lift rear wheel flare to remove 2 screws inside on both sides.</p>
	<p>9. Remove bumper trim panel via 2 x locking screws.</p>
	<p>10. Remove 2 screws holding heat shield on both sides.</p>

**HAYMAN REESE**  
**PART No: 02888RW**  
**BMW X6 01/2008-ON (STANDARD BUMPER ONLY)**

**INSTALLATION INSTRUCTIONS**

PLEASE ENSURE THAT INSTRUCTIONS ARE UNDERSTOOD PRIOR TO FITMENT



11. From the rear, remove 5 screws holding bumper frame.
12. Release bumper skin from both sides, disconnect any wiring and remove bumper skin from vehicle.



13. Remove impact beam and discard, please retain nuts for towbar installation.



14. Fasten towbar using nuts from impact beam. Torque all fasteners to specification.

**HAYMAN REESE**  
PART No: 02888RW  
BMW X6 01/2008-ON (STANDARD BUMPER ONLY)

**INSTALLATION INSTRUCTIONS**

PLEASE ENSURE THAT INSTRUCTIONS ARE UNDERSTOOD PRIOR TO FITMENT

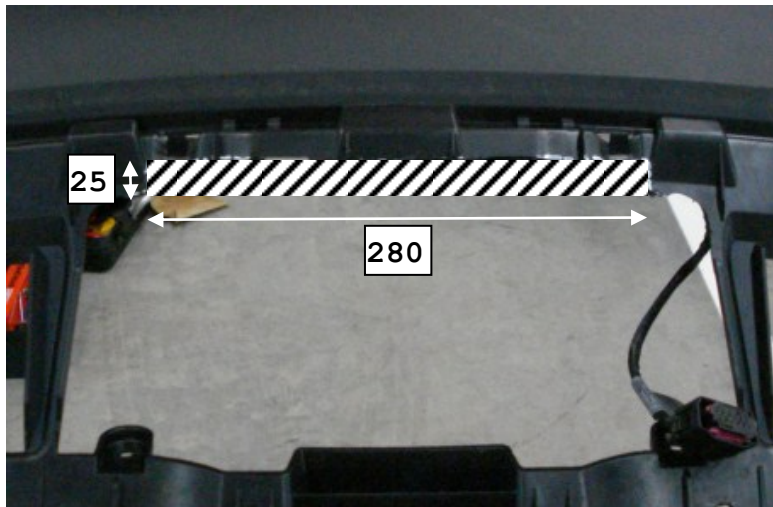

15. Cut bumper support frame 280mm wide 25mm high from the edge of opening cavity.

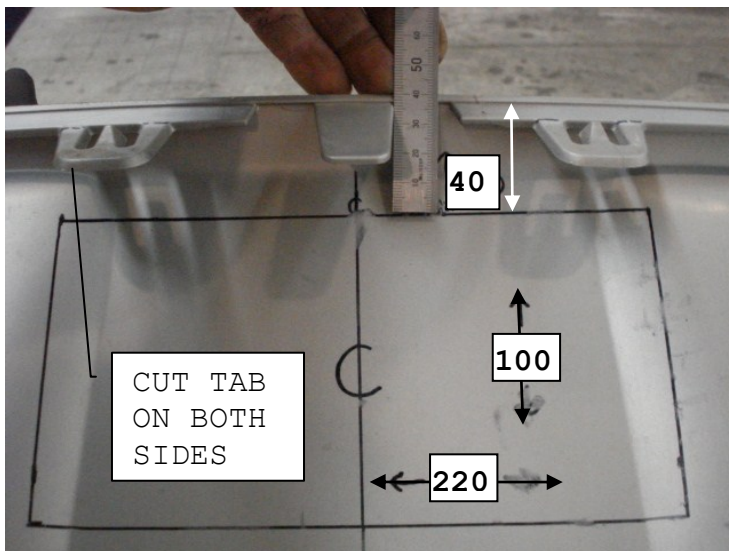

16. Cut tabs near centre portion. From the edge of the panel measure 40mm cut 220mm wide 100mm high from the centre.

17. Refit bumper skin in reverse order.



**HAYMAN REESE**  
**PART No: 100707-WL**  
**BMX X1, X5 & X6**

**INSTALLATION INSTRUCTIONS**

PLEASE ENSURE THAT INSTRUCTIONS ARE UNDERSTOOD PRIOR TO FITMENT

**Wiring Loom Installation Instructions**

**BMX X1, X5 & X6**  
**Part No: 100707-WL**

**ECU Required: 04829**  
**Tail Harness Length Required: 1800mm**  
**RPA Override Switch Part No: 04848 (If Fitted)**

**Wiring Loom Installation Time: Approx 30 Mins**

Issue Date 11-07-11

Page 1

Part No: 100707-WL

Hayman Reese (Cequent)  
PO Box 4050, Dandenong South VIC 3164  
Phone 1800 812 017 Email [info@haymanreese.com.au](mailto:info@haymanreese.com.au)

[www.haymanreese.com.au](http://www.haymanreese.com.au)



**HAYMAN REESE**  
**PART No: 100707-WL**  
**BMX X1, X5 & X6**

**INSTALLATION INSTRUCTIONS**

**PLEASE ENSURE THAT INSTRUCTIONS ARE UNDERSTOOD PRIOR TO FITMENT**

1. Remove the floor carpet cover (1).
2. Remove the LHS & RHS access panel covers (2).



3. Remove the tool storage tray (1) by first removing the fasteners.



4. Remove the LHS storage compartment (1).



Issue Date 11-07-11

Page 2

Part No: 100707-WL

Hayman Reese (Cequent)  
PO Box 4050, Dandenong South VIC 3164  
Phone 1800 812 017 Email [info@haymanreese.com.au](mailto:info@haymanreese.com.au)

[www.haymanreese.com.au](http://www.haymanreese.com.au)



**HAYMAN REESE**  
**PART No: 100707-WL**  
**BMX X1, X5 & X6**

**INSTALLATION INSTRUCTIONS**

**PLEASE ENSURE THAT INSTRUCTIONS ARE UNDERSTOOD PRIOR TO FITMENT**

5. Remove the RHS storage compartment (1).



6. In the RHS of the luggage compartment, lift up the carpet cover and remove the vehicle grommet (1).



7. From the outside of the vehicle, drill out the grommet hole (1) to Ø31mm. File any rough or sharp edges and spray on rust inhibitor.



Issue Date 11-07-11

Page 3

Part No: 100707-WL

Hayman Reese (Cequent)  
PO Box 4050, Dandenong South VIC 3164  
Phone 1800 812 017 Email [info@haymanreese.com.au](mailto:info@haymanreese.com.au)

[www.haymanreese.com.au](http://www.haymanreese.com.au)



**HAYMAN REESE**  
**PART No: 100707-WL**  
**BMX X1, X5 & X6**

## INSTALLATION INSTRUCTIONS

**PLEASE ENSURE THAT INSTRUCTIONS ARE UNDERSTOOD PRIOR TO FITMENT**

8. Following the table below, connect the ezy tap (1) to the vehicle harness wire (2) and then connect the trailer harness terminal (3) to the corresponding wire (2).

Function	Trailer Patch	Vehicle Connector
L.IND	YELLOW / BLACK	BLUE / BROWN

**For MY10 X5 Vehicles:**

Function	Trailer Patch	Vehicle Connector
L.IND	YELLOW / BLACK	GREEN / BLUE

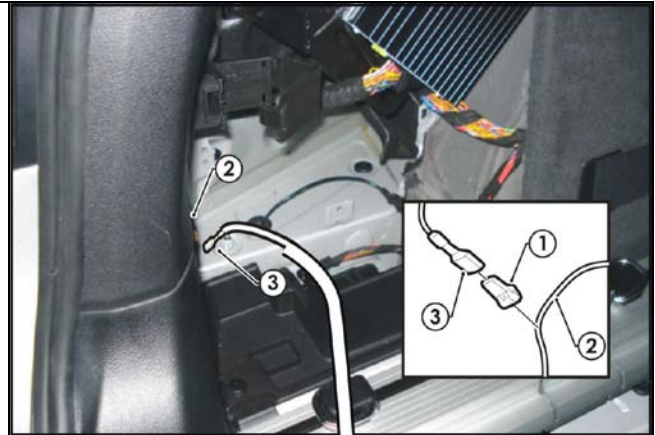

9. Route the trailer harness (P/No: 100707-WL) (1) along the vehicle harness and towards the RHS tail light connector.  
 10. Connect the trailer harness ground ring terminal (2) to the existing vehicle ground point.

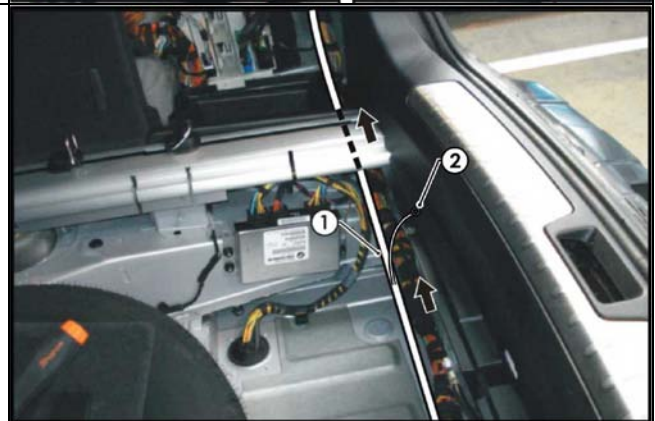

11. Following the table below, connect the ezy taps (1) to the vehicle harness wires (2) and then connect the trailer harness terminals (3) to the corresponding wires (2).

Function	Trailer Patch	Vehicle Connector
R.IND	GREEN / BLACK	BLUE / BROWN
REVERSE	BLACK / WHITE	BLACK / YELLOW
TAIL	BROWN / BLACK	YELLOW / PURPLE
BRAKES	RED / BLACK	BLACK / WHITE

**For MY10 X5 Vehicles:**

Function	Trailer Patch	Vehicle Connector
R.IND	GREEN / BLACK	BLUE / BROWN
REVERSE	BLACK / WHITE	BLUE / YELLOW
TAIL	BROWN / BLACK	YELLOW / PURPLE
BRAKES	RED / BLACK	BLACK / BLUE

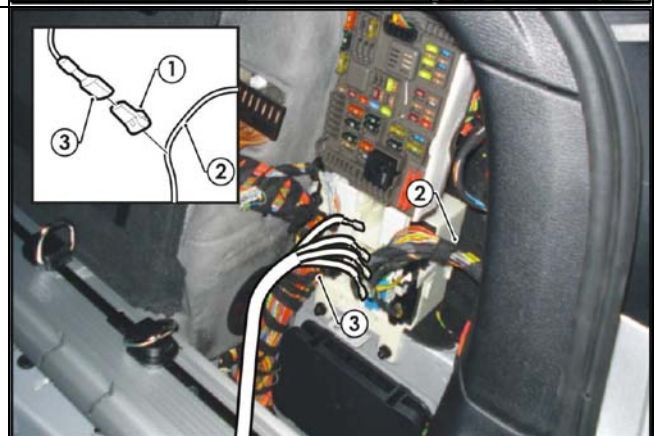

Issue Date 11-07-11

Page 4

Part No: 100707-WL

Hayman Reese (Cequent)  
 PO Box 4050, Dandenong South VIC 3164  
 Phone 1800 812 017 Email [info@haymanreese.com.au](mailto:info@haymanreese.com.au)

**HAYMAN REESE**  
**PART No: 100707-WL**  
**BMX X1, X5 & X6**

**INSTALLATION INSTRUCTIONS**

**PLEASE ENSURE THAT INSTRUCTIONS ARE UNDERSTOOD PRIOR TO FITMENT**

12. Insert a supplied 20A fuse (1) into the upper fuse slot on the add-a-fuse harness (2).
13. Connect the trailer patch harness ORANGE power wire 1-way connector (3) to the add-a-fuse 1-way mating connector (4).
14. Connect the add-a-fuse to the vehicle fuse panel into the now unoccupied fuse location (5) as shown.

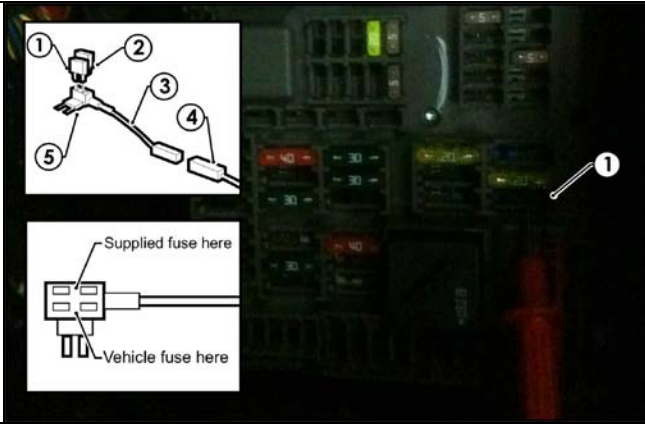

15. Connect the trailer harness 12-way connector (1) to the ECU (No: 04829) (2).

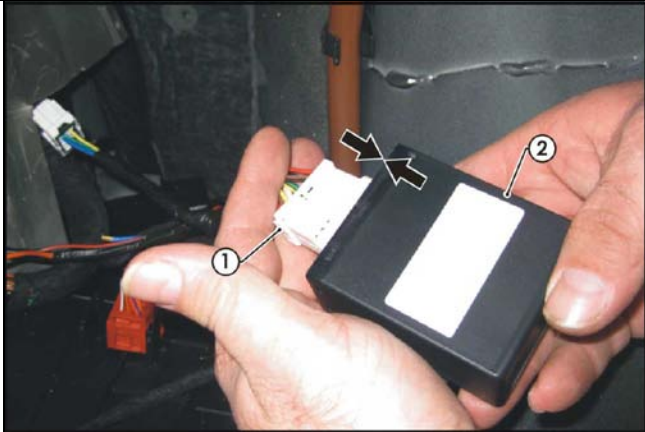

16. Slot the ECU (1) into the vacant slot underneath the fuse panel.



Issue Date 11-07-11

Page 5

Part No: 100707-WL

Hayman Reese (Cequent)  
PO Box 4050, Dandenong South VIC 3164  
Phone 1800 812 017 Email [info@haymanreese.com.au](mailto:info@haymanreese.com.au)

[www.haymanreese.com.au](http://www.haymanreese.com.au)



**HAYMAN REESE**  
**PART No: 100707-WL**  
**BMX X1, X5 & X6**

**INSTALLATION INSTRUCTIONS**

**PLEASE ENSURE THAT INSTRUCTIONS ARE UNDERSTOOD PRIOR TO FITMENT**

17. Connect the trailer harness 8-way connector (1) to the tail harness (tail length 1800mm) mating connector (2).

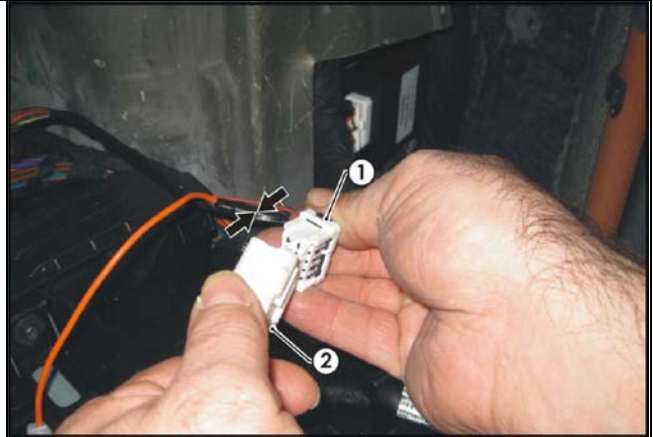

18. Route the tail harness (1) through the previously drilled out grommet hole and towards the towbar.  
19. Mount the trailer socket (2) to the towbar mounting bracket using M4 fasteners (not supplied).  
20. Ensure the tail harness grommet is seated correctly and secured in place using a cable tie (not supplied).



21. Test the Trailer Harness function using a Light Board or multimeter.  
22. Secure all Harnesses using cables ties (not supplied).  
23. Re-fit all removed parts and secure all fasteners, ensuring there are no squeaks or rattles.  
24. Place the instructions in the glove box after fitment.

Issue Date 11-07-11

Page 6

Part No: 100707-WL

Hayman Reese (Cequent)  
PO Box 4050, Dandenong South VIC 3164  
Phone 1800 812 017 Email [info@haymanreese.com.au](mailto:info@haymanreese.com.au)

[www.haymanreese.com.au](http://www.haymanreese.com.au)

